

Study of Phase Advance Angle Control (PAAC) Technique for Brushless DC (BLDC) Motor

N. Z. Yahaya & M. N. Abu-Bakar

Electrical & Electronic Engineering Department
Universiti Teknologi PETRONAS
31750 Bandar Seri Iskandar, Perak, Malaysia
norzaihar_yahaya@petronas.com.my

M. S. Mohd

Mechanical Engineering Department
Universiti Teknologi PETRONAS
31750 Bandar Seri Iskandar, Perak, Malaysia
syafuddin@petronas.com.my

Abstract — The brushless DC (BLDC) motor is recognized by the linear speed to voltage and torque to current respectively. It possesses fast dynamic response and high power density with high proportion of torque in spite of small size drive. However, it is difficult for conventional BLDC motor drives where they require wide range of operating speed. This is due to the torque and speed response characteristics at high speed operating mode in which deteriorated by the motor inductance components in stator winding. Phase advance angle control (PAAC) technique is used to control the phase current and improve torque and speed responses in high speed operating mode. This paper discusses the design of high-speed lossless BLDC motor using simulation where the compatible phase advance motor drive is developed. The results are then compared with laboratory proof for validation.

Keywords — *Brushless DC Motor; Modeling; Phase Advance Angle; Torque*

I. INTRODUCTION

The permanent magnet brushless DC (BLDC) motors have gained attention and are widely used in industries such as automotive, aerospace, household appliances, industrial automation equipments and instrumentation. As conventional DC motors use mechanical commutator and brushes, they are subject to wear and require maintenance. BLDC motors are electronically commutated which make them virtually maintenance-free motor. They have many advantages over conventional DC and induction motors. Some of the advantages are long operating life, noiseless operation, high dynamic response, higher speed range, better speed versus torque characteristics and highest power capability for a given size and weight. Such advantages are very useful for many applications where efficiency, space and weight are critical factors especially in land vehicle drive systems. BLDC motors can be categorized based on phase number, construction, flux direction, and back EMF generation.

Commonly, there are two different flux directions for BLDC motors, namely sinusoidal and trapezoidal. The trapezoidal-type is famous due to lower price and the ability to produce more output power per frame size than other kinds of motors [1]. Although this type of BLDC motor is commonly used, there are drawbacks. First, it is difficult to control at high speed and secondly, production of more torque ripples compared to sinusoidal-typed [2]. In most application,

particularly for electric vehicles, a wide range speed control of motor drives is necessary. This paper focuses on overcoming the inability to control motor at high speed using Phase Advance Angle Control (PAAC) technique where the constant power speed range extension of BLDC motor will be demonstrated. Previously, there are several techniques introduced to extend BLDC motor speed limit such as field weakening control, overlapping and PWM chopping. Fundamentally, PAAC can be achieved by two approaches. First is by adjusting the Hall sensors position at a leading position and second, by advancing the inverter gating time such that the phase angle of the stator current can lead corresponding back EMF.

Among these two approaches, advancing the inverter gating time is more popular which it has given highly attention by many researches. For example, the new inverter scheme using different advanced algorithm to drive the motor drive. In this work, PAAC technique will be developed by advancing inverter gating time and improving the algorithm to control the firing angle of inverter gates.

II. BLDC MOTOR

Brushless DC (BLDC) motors are referred as Direct Current (DC) because of DC power application to various stator coils in predetermined sequential pattern in driving the coils. They are also effectively known as Alternating Current (AC) where the commutation is done electronically via an integrated inverter. Eventually, this produces an AC electric signal from DC electric source to drive the motor by applying additional sensor to control the inverter output [3].

A. Modeling & Analysis

In order to implement PAAC effectively, an optimized model is proposed. Fig. 1 shows the BLDC motor drive model used in this work. The model is developed based on several assumptions:

- All power semiconductor components in inverter are ideal.
- All losses including stator and rotor iron losses are negligible.
- The motor is not saturated.

- Mutual inductances are constant and stator resistance at every phase is equal.

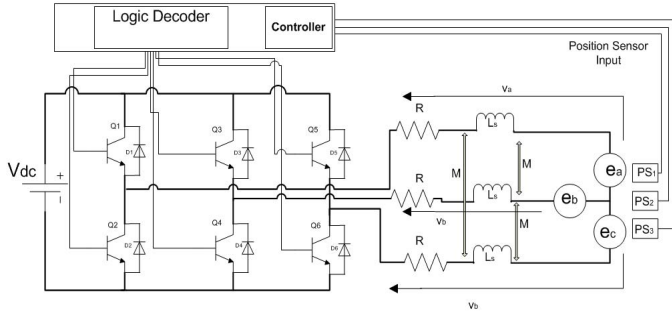

Fig. 1. BLDC Motor Drive Model

The BLDC motor operating under these conditions can be represented in state space equation as:

$$\begin{bmatrix} v_a \\ v_b \\ v_c \end{bmatrix} = \begin{bmatrix} R & 0 & 0 \\ 0 & R & 0 \\ 0 & 0 & R \end{bmatrix} \begin{bmatrix} i_a \\ i_b \\ i_c \end{bmatrix} + \begin{bmatrix} L & 0 & 0 \\ 0 & L & 0 \\ 0 & 0 & L \end{bmatrix} \frac{d}{dt} \begin{bmatrix} i_a \\ i_b \\ i_c \end{bmatrix} + \begin{bmatrix} e_a \\ e_b \\ e_c \end{bmatrix} \quad (1)$$

where v_a, v_b , and v_c are the voltage supply for each phase. i_a, i_b , and i_c are the rectangular shaped phase currents. e_a, e_b , and e_c are the trapezoidal back EMFs. R is resistance for each phase and L is the phase inductance (self inductance, L_s with mutual inductance, M). For simplicity, the following equations are presented for phase A only by considering the others two phases (phase B and C). They have the same magnitude but vary in phases. The Kirchoff's Voltage Law (KVL) equation for each phase equation is:

$$v = Ri + L \frac{di}{dt} + e \quad (2)$$

From Eq. (2), the electromagnetic torque can be obtained using Eq. (3).

$$T_e = K_t \times I_{phase} \quad (3)$$

where K_t is the BLDC motor torque constant, I_{phase} is phase current and T_e is motor torque. The importance of having previous Eq. (2) and (3) is to represent the system by an equivalent rotational system. Fig. 2 shows the rotational system of BLDC motor and Fig. 3 is the equivalent rotational system block diagram.

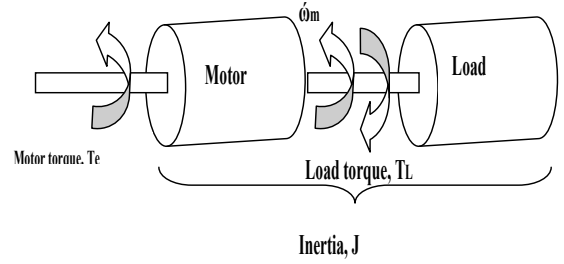

Fig. 2. Rotational System of BLDC motor

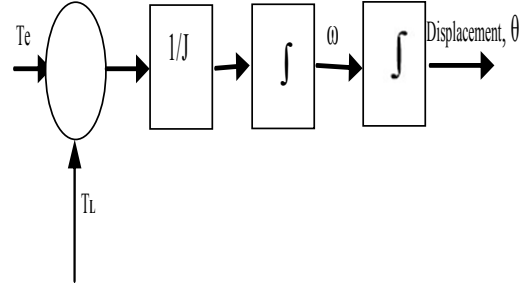

Fig. 3. Equivalent Rotational System of BLDC Motor Block Diagram

The system can be described by a first order mechanical system:

$$T_e = T_L + \frac{d(J\omega_m)}{dt} \quad (4)$$

For the system with constant inertia, $dJ\omega_m/dt = 0$, Eq. (4) can be rewritten as:

$$T_e = T_L \quad (5)$$

where T_L is load torque and $J\omega_m/t$ is inertia.

B. Issues in Handling BLDC Motor

The BLDC motors have superiority in high power density, high efficiency, high dynamic response, good controllability and long operating life. In most applications where high power BLDC motors are needed, particularly for electric vehicles, tools machines, etc, it is necessary to have wide range of speed control for motor drives [2, 4]. Fig. 4 shows the torque-speed envelope of BLDC motor.

When the motor operates at lower speed less than base speed, the motor drive will be required to provide a constant output torque known as *Constant-Torque Operation*. When the motor operates above the base speed, the load torque will decrease with speed. The base speed can be defined as the highest speed at which rated torque can be developed in low speed current regulation mode. Hence, instead of producing constant output torque, constant-power operation is preferred because it can substantially reduce the size and cost of motor drive [4].

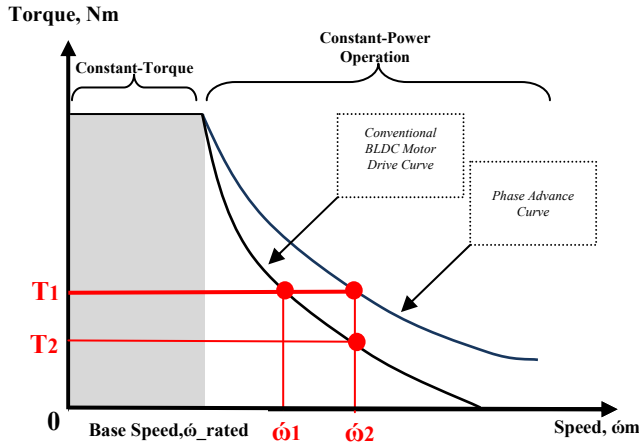

Fig. 4. Torque versus Speed Envelope of BLDC Motor

However, a conventional drive system cannot operate along the *Phase Advance Approach* curve which is known as the power limit curve. It is the maximum speed for a given load torque due to voltage saturation. The conventional motor drive system can only operate along the *Conventional BLDC motor Drive* curve. It needs additional special control technique to extend the constant power speed range for the motor.

high speed mode, phase current has larger delay of phase shift, θ as shown in Fig. 5(c).

Therefore, the idea of the scheme is to control the line current as a rectangular waveform while keeping it in phase with the corresponding phase back EMF for the generation of the optimal constant output power. By applying PAAC, the phase current is able to achieve the rated current level as shown in Fig. 5(d).

C. PAAC Technique

The optimization of drive system is required to improve the performance of phase current. In order to overcome this issue, PAAC was introduced in 1995, by [5]. They proposed this technique to extend the constant power speed range of BLDC motors, thus overcame the weakness in the controller design. This technique was done by shifting (advancing) the applied voltage. In other words, it is achieved by injecting the current earlier from the back EMF.

There are two types of electromotive forces in the phase winding of BLDC motors. They are back EMF which is induced by the magnet field of a rotating of permanent magnet and transformer electromotive force, by the transformer action of the time-varying stator current in the phase winding. The concern arises when the BLDC motors operate above the base speed where the phase-current leads the phase EMF. Here, there is a corresponding advance angle for every given reference speed. According to [5], in high speed operating mode, the winding phase resistance is negligible since the back EMF is higher than the applied voltage ($e > U$). So they introduced the 3-phase permanent magnet BLDC motors.

In 1997, the brushless DC motor using phase timing advancement (Conventional Phase Advance) was invented [6] but the patent inhibited same limitations with method proposed by [7] where it needed an equivalent large motor inductance per phase. Nowadays, the BLDC motors are usually constructed from rare-magnet materials such as samarium-cobalt or neodymium-iron-boron and these materials have low internal inductance. Depending on the value of inductance, the motor current magnitude may be of several times greater than rated value when operating in high speed mode [7, 8].

In 2007, the phase advance approach by overcoming the weakness of method proposed by [5] has been completed by [9]. They only examined the phase current when the amplitude of back EMF is higher than the amplitude of applied voltage by assuming the winding resistance is negligible. However practically, the amplitude of the back EMF is lower than the amplitude of applied voltage and the phase winding resistance is not always negligible.

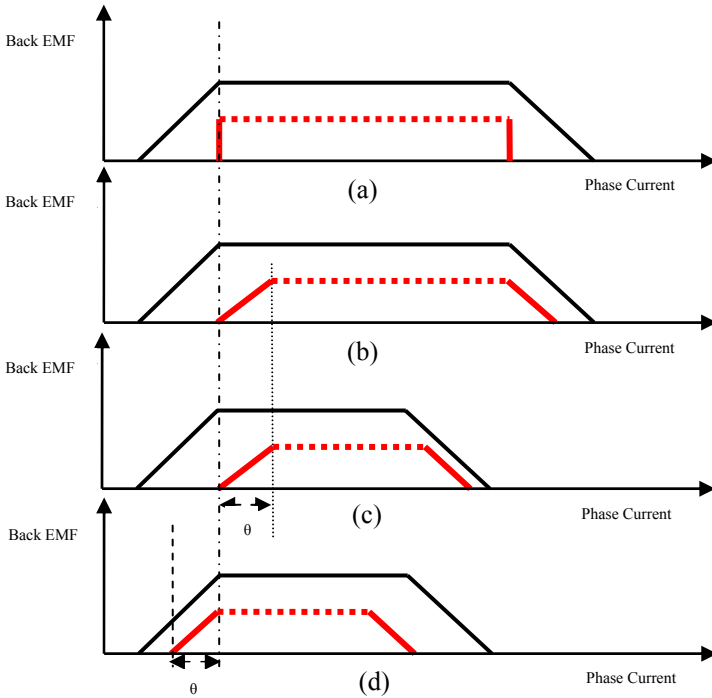

Fig. 5. Phase Current and Back EMF waveforms

Theoretically, the efficiency of BLDC motors decreases when they are operating in high speed operating mode. Fig. 5(a) shows the ideal waveforms of rectangular shaped phase current and trapezoidal back EMF where phase current is in the same phase with back EMF. But these ideal waveforms are unrealistic due to resistance and inductance components of the stator winding. Fig. 5(b) shows the actual phase current and back EMF waveforms. When the motors are operating in

III. METHODOLOGY

A larger phase advanced angle that resulted in larger leading angle was designed so that a better performance could be achieved. Thus, they introduced the estimation of advance angle which could be regulated by an approximate linear

relationship with BLDC motor speed (linear relationship). However, the value of advance angle is not linear with motor speed.

Instead of approximating the value of phase advance as a linear relationship, the phase advance value will be calculated based on motor speed. There are two types of BLDC motor operating modes: low speed operating mode (below base speed) and high speed operating mode (above base speed). The PAAC technique is more efficient when the motor is operated in high speed operating mode compared low speed operating mode.

A. Low Speed Operating Mode

When motor is in low speed operating mode, the output torque is directly proportional to the amplitude of phase current. This is represented by Eq. (3). The calculation is based on RMS current. Under this operating mode, the current flow through the phase winding is given by 120° in every half cycle. Thus, the RMS current can be represented as:

$$I_{rms} = \sqrt{\frac{1}{T} \int_0^T i^2 dt} = \sqrt{\frac{1}{\pi} \int_{\frac{\pi}{6}}^{\frac{5\pi}{6}} I^2 d(\omega t)} = \frac{\sqrt{6}}{3} I \quad (6)$$

The Eq. (6) can be re-written as:

$$T = \frac{3}{\sqrt{6}} Kt \times I_{rms} = Kt^* \times I_{rms} \quad (7)$$

B. High Speed Operating Mode

For operation of BLDC motor above base speed, the concept of constant power control is adopted. Here, the given rotational speed, ωm and T satisfy Eq. (8).

$$T = \frac{\omega m_{rated}}{\omega m} \times T_{rated} \quad (8)$$

where T is the output torque, T_{rated} is the rated torque, ωm_{rated} is rated mechanical speed of BLDC motor and ωm is the mechanical speed of BLDC motors. With respect to phase advance angle, the RMS current is given by Eq. (8). The RMS current can also be represented as a function of mechanical speed and degree of angle as shown in Eq. (9).

$$I_{rms} = f(\omega, \theta) = \frac{T}{Kt^*} \quad (9)$$

where ω is electrical speed which can be obtained from $\omega m = \omega/2$

IV. RESULTS AND DISCUSSION

The simulation and experiment have been carried out to study the effect of PAAC technique on BLDC motors. The

main purpose is to produce the maximum speed by varying the phase advance angle value without resulting in a current exceeding the rated current phase value of BLDC motors at different load torques. The primary focus is on the effect of phase advance. The work on simulation using a BLDC motor model and physical test on actual BLDC motors has been conducted.

A. Simulation Results

The simulation study has been carried out using the BLDC motor and motor drive model which is developed based on actual BLDC motor parameters. Fig. 6 shows the simulation results for varying phase advance angle on brushless DC motors. Here, the angle was taken as 0° , 15° and 30° respectively. The graph shows that torque will be reduced as the value of phase advance angle increases and so does the speed. The characteristics of torque and speed were examined comprehensively. The blue line indicates the conventional motor drive (0° phase advance). The maximum speed occurs when torque is equal to zero, that is, 1,750 rpm. The red line indicates the phase advance for 15° . It is noticed that the maximum torque is slightly reduced at constant torque operation and also when the torque is equal to zero, the maximum speed reaches 1,990 rpm. The green line indicates phase advance angle for 30° . The maximum torque is reduced from 23 N.m to 30 N.m. Here, the maximum speed at torque equal to zero has increased to 2,480 rpm. From the simulation, it is found that as the phase advances angle increases, the maximum speed will also increase.

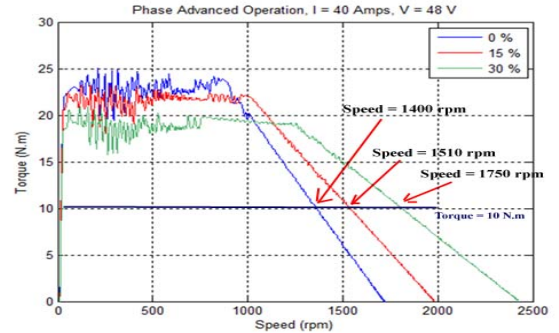

Fig. 6. Torque versus Speed Characteristic for Phase Advance Angle Control Method

Referring to Fig. 6, the motor torque is equal to 10 Nm for every phase advance angle. The conventional BLDC motor speed without applying phase advance is 1,400 rpm. At 15° phase advance, the speed is 1,510 rpm and the efficiency has improved by 7.86 % whilst at 30° , the speed is 17,500 rpm having efficiency pick-up by 25 %.

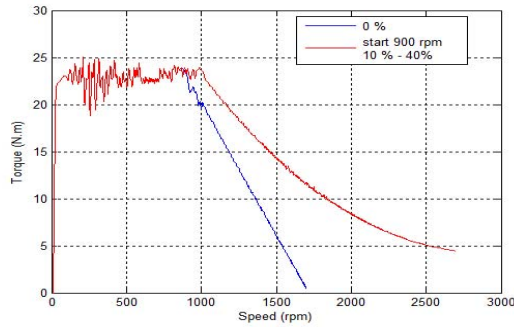

Fig. 7. Torque versus Speed Characteristic

Fig. 7 shows that effect of applying 10° of phase advance at speed equal to 900 rpm. It is found that the speed continuously increases until phase advance angle reaches 40° . Interestingly, without changing the torque characteristic at constant torque operation (conventional motor drive), the PAAC technique is able to extend the BLDC motor operation into constant power operation (preferred).

B. Experimental Results

The physical test was conducted at the same base speed (2,700 rpm) but with two different phase advance angles: the speed with 0° phase advance angle and 40° .

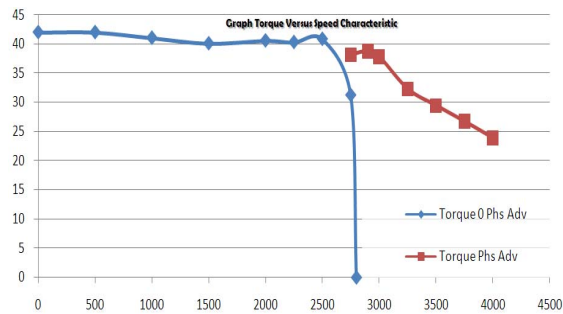

Fig. 8. Torque versus Speed Characteristics

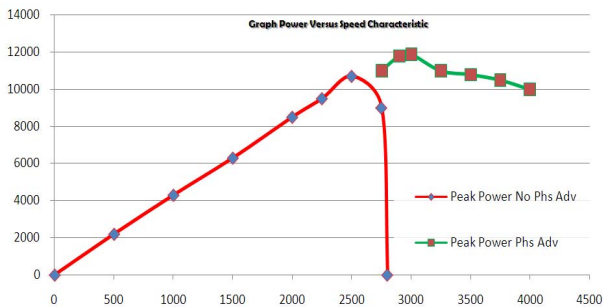

Fig. 9. Power versus Speed Characteristics

Fig. 8 shows the torque versus speed characteristics of BLDC motors when operating under phase advance effect. It shows that by applying PAAC technique, it is able to extend the speed beyond designed motor base speed. For motor efficiency, it is measured at torque equal to 31 Nm for every phase advance angle. The conventional BLDC motor speed without phase advance is only measured at 2,700 rpm. At 40°

phase advance, the speed is 3,350 rpm and the efficiency has improved by 21.8 %. Lastly, Fig. 9 shows the power versus speed characteristics. It is found that the PAAC technique has also successfully extended the speed with the same amount of supply power

V. CONCLUSION

In this paper, the effect of phase advance angle has been studied using simulation and physical test. From simulation results, the phase advance angle of 30° can be used to improve the efficiency of BLDC motors by 25 %. On the other hands, through experimentation, the phase advance angle of 40° reflects the improvement of the BLDC motor by 21.8 %. The results are validated. Therefore, the proposed PAAC technique is proven to further improve the controller and BLDC motor drive system

ACKNOWLEDGMENT

The authors would like to thank Universiti Teknologi PETRONAS for providing financial support for the publication of this work.

REFERENCES

- [1] K. Tabarraee, J. Iyer, Chiniforoosh and Jatskevich, "Comparison of Brushless DC Motors with Trapezoidal and Sinusoidal Back EMF", *Canadian Conf. Elec. & Comp. Engr.*, pp. 803-806, 2011.
- [2] P. Yedamale, "Brushless DC Motor Fundamentals", *Microchip Tech. Inc.*, 2003.
- [3] S. I. Park, T. S. Kim, S. C. Ahn and D. S. Hyun, "An Improved Current Control Method for Torque Improvement of High Speed BLDC Motor", *IEEE App. Pwr Electr. Conf. & Exp.*, Vol. 1, pp. 294-299, 2003.
- [4] C. L. Chu, M. C. Tsai and H. Y. Chen, "Torque Control of Brushless DC Motors Applied to Electric Vehicles", *IEEE Int. Conf. Machines & Drives*, pp. 82-87, 2001.
- [5] C. C. Chan, J. Z. Jiang, W. Xia and K. T. Chau, "Novel Wide Range Speed Control of Permanent Magnet Brushless Motor Drives", *IEEE Trans. Pwr Electr.*, Vol. 10, pp. 539-546, 1995.
- [6] C. S. Cambier and J. F. Lutz, "Brushless Motor using Phase Timing Advancement", *US Patent No 5677605*, 1997
- [7] J. S. Lawler, J. M. Bailey, J. W. McKeever and J. Pinto, "Limitations of the Conventional Phase Advanced Method for Constant Power Operation of Brushless DC Motor", *IEEE Southeast Conf.*, pp. 174-180, 2002.
- [8] J. S. Lawler, J. M. Bailey, J. W. McKeever and J. Pinto, "Extending Constant Power Speed Range of Brushless DC Motor through Dual Mode Inverter Control – Part I: Theory and Simulation", *IEEE Trans. Pwr Electr.*, Vol. 19, Iss. 3, pp. 783-793, 2004.
- [9] B. M. Nguyen and M. C. Ta, "Phase Advanced Approach to Expand the Speed Range of Brushless DC Motor", *IEEE Conf. Pwr Electr & Sys.*, pp. 1255-1262, 2007.